



Test Report No.: ICP20120006-3



IC TEST REPORT (RSS-139)

Product: B Series
Model No.: B402, B404
IC: 20127-B402
Applicant: Particle Industries, Inc
Address: 126 Post St, 4th floor, San Francisco, CA 94108 USA
Manufacturer: Particle Industries, Inc
Address: 126 Post St, 4th floor, San Francisco, CA 94108 USA
Prepared by: BV 7Layers Communications Technology (Shenzhen) Co. Ltd
Lab Location: No. B102, Dazu Chuangxin Mansion, North of Beihuan Avenue, North Area, Hi-Tech Industrial Park, Nanshan District, Shenzhen, Guangdong, China
TEL: +86 755 8869 6566
FAX: +86 755 8869 6577
E-MAIL: customerservice.sw@bureauveritas.com
Report No.: ICP20120006-3
Received Date: Jun. 06, 2019
Test Date: Jun. 07, 2019 ~ Jul. 10, 2019
Issued Date: Dec. 24, 2020

This report should not be used by the client to claim product certification, approval, or endorsement by A2LA or any government agencies.

This report is governed by, and incorporates by reference, CPS Conditions of Service as posted at the date of issuance of this report at <http://www.bureauveritas.com/home/about-us/our-business/cps/about-us/terms-conditions> and is intended for your exclusive use. Any copying or replication of this report to or for any other person or entity, or use of our name or trademark, is permitted only with our prior written permission. This report sets forth our findings solely with respect to the test samples identified herein. The results set forth in this report are not indicative or representative of the quality or characteristics of the lot from which a test sample was taken or any similar or identical product unless specifically and expressly noted. Our report includes all of the tests requested by you and the results thereof based upon the information that you provided to us. Measurement uncertainty is only provided upon request for accredited tests. You have 60 days from date of issuance of this report to notify us of any material error or omission caused by our negligence or if you require measurement uncertainty; provided, however, that such notice shall be in writing and shall specifically address the issue you wish to raise. A failure to raise such issue within the prescribed time shall constitute your unqualified acceptance of the completeness of this report, the tests conducted and the correctness of the report contents.



TABLE OF CONTENTS

RELEASE CONTROL RECORD 4

1 CERTIFICATION 5

2 SUMMARY OF TEST RESULTS 6

2.1 MEASUREMENT UNCERTAINTY 6

2.2 TEST SITE AND INSTRUMENTS 7

3 GENERAL INFORMATION..... 8

3.1 GENERAL DESCRIPTION OF EUT 8

3.2 CONFIGURATION OF SYSTEM UNDER TEST 9

3.3 DESCRIPTION OF SUPPORT UNITS 10

3.4 DESCRIPTION OF TEST MODES..... 10

3.5 GENERAL DESCRIPTION OF APPLIED STANDARDS11

4 TEST TYPES AND RESULTS 12

4.1 OUTPUT POWER MEASUREMENT AND POWER CONTROL..... 12

4.1.1 LIMITS OF OUTPUT POWER MEASUREMENT 12

4.1.2 TEST PROCEDURES 12

4.1.3 TEST SETUP 13

4.1.4 TEST RESULTS 14

4.2 FREQUENCY STABILITY MEASUREMENT 16

4.2.1 LIMITS OF FREQUENCY STABILIIITY MEASUREMENT..... 16

4.2.2 TEST PROCEDURE 16

4.2.3 TEST SETUP 17

4.2.4 TEST RESULTS 17

4.3 OCCUPIED BANDWIDTH MEASUREMENT 18

4.3.1 LIMITS OF OCCUPIED BANDWIDTH MEASUREMENT 18

4.3.2 TEST SETUP 18

4.3.3 TEST PROCEDURES 18

4.3.4 TEST RESULTS 18

4.4 PEAK TO AVERAGE RATIO 19

4.4.1 LIMITS OF PEAK TO AVERAGE RATIO MEASUREMENT..... 19

4.4.2 TEST SETUP 19

4.4.3 TEST PROCEDURES 19

4.4.4 TEST RESULTS 19

4.5 BAND EDGE MEASUREMENT 20

4.5.1 LIMITS OF BAND EDGE MEASUREMENT..... 20

4.5.2 TEST SETUP 20

4.5.3 TEST PROCEDURES 21

4.5.4 TEST RESULTS 21

4.6 CONDUCTED SPURIOUS EMISSIONS..... 22

4.6.1 LIMITS OF CONDUCTED SPURIOUS EMISSIONS MEASUREMENT 22

4.6.2 TEST PROCEDURE 22

4.6.3 TEST SETUP 22

4.6.4 TEST RESULTS 22

4.7 RADIATED EMISSION MEASUREMENT..... 23

4.7.1 LIMITS OF RADIATED EMISSION MEASUREMENT 23

4.7.2 TEST PROCEDURES 23

4.7.3 DEVIATION FROM TEST STANDARD 23



**BUREAU
VERITAS**

Test Report No.: ICP20120006-3

4.7.4	TEST SETUP	24
4.7.5	TEST RESULTS	25
5	INFORMATION ON THE TESTING LABORATORIES	33
6	APPENDIX A – MODIFICATIONS RECORDERS FOR ENGINEERING CHANGES TO THE EUT BY THE LAB	34



Test Report No.: ICP20120006-3

RELEASE CONTROL RECORD

ISSUE NO.	REASON FOR CHANGE	DATE ISSUED
IC190606W003-3	Original release	Jul. 19, 2019
ICP20120006-3	Based on the original report IC190606W003-3 change the product name and models, which not affect RF function. So all the test data re-use from IC190606W003-3.	Dec. 24, 2020



1 CERTIFICATION

PRODUCT: B Series
BRAND NAME: Particle
MODEL NAME: B402, B404
APPLICANT: Particle Industries, Inc
TESTED: Jun. 07, 2019 ~ Jul. 10, 2019
TEST SAMPLE: Production Unit
TEST STANDARDS: **Canada RSS-139, Issue 3, July 2015**
Canada RSS-Gen, Issue 5, April 2018
ANSI C63.26 - 2015

The above equipment has been tested by **BV 7Layers Communications Technology (Shenzhen) Co. Ltd** and found compliance with the requirement of the above standards. The test record, data evaluation & Equipment Under Test (EUT) configurations represented herein are true and accurate accounts of the measurements of the sample's EMC characteristics under the conditions specified in this report.

PREPARED BY : Alex **DATE :** Dec. 24, 2020
(Alex Chen / Engineer)

APPROVED BY : Luke Lu **DATE :** Dec. 24, 2020
(Luke Lu / Manager)

2 SUMMARY OF TEST RESULTS

The EUT has been tested according to the following specifications:

APPLIED STANDARD: IC RSS-139, RSS-Gen <LTE Band4>			
STANDARD SECTION	TEST TYPE AND LIMIT	RESULT	REMARK
RSS-Gen			
6.7	Occupied Bandwidth	N/A(see note)	Meet the requirement.
STANDARD SECTION	TEST TYPE AND LIMIT	RESULT	REMARK
RSS-139			
6.4	Frequency Stability AFC Freq. Error vs. Voltage AFC Freq. Error vs. Temperature	N/A(see note)	Meet the requirement of limit.
6.5	Maximum Peak Output Power	N/A(see note)	Meet the requirement of limit.
6.5	peak-to-average power ratio	N/A(see note)	Meet the requirement of limit.
6.6	Band Edge Measurements	N/A(see note)	Meet the requirement of limit.
6.6	Conducted Spurious Emissions	N/A(see note)	Meet the requirement of limit.
6.6	Radiated Spurious Emissions	PASS	Meet the requirement of limit. Minimum passing margin is -16.49dB at 388.900MHz.
6.7	Transmitter Power Control	N/A(see note)	Meet the requirement

Note: more detail please refer to the original report IC190606W003-3

* Refer to KDB 971168 D01 Power Meas License Digital Systems v03r01

2.1 MEASUREMENT UNCERTAINTY

Where relevant, the following measurement uncertainty levels have been estimated for tests performed on the EUT as specified in CISPR 16-4-2:

MEASUREMENT	FREQUENCY	UNCERTAINTY
Conducted emissions	9kHz~30MHz	2.66dB
Radiated emissions	9KHz ~ 30MHz	2.68dB
	30MHz ~ 1GMHz	3.26dB
	1GHz ~ 18GHz	4.48dB
	18GHz ~ 40GHz	4.12dB

This uncertainty represents an expanded uncertainty expressed at approximately the 95% confidence level using a coverage factor of k=2.



2.2 TEST SITE AND INSTRUMENTS

Equipment	Manufacturer	Model No.	Serial No.	Last Cal.	Next Cal.
MXE EMI Receiver	KEYSIGHT	N9038A-544	MY54450026	Feb. 26,19	Feb. 25,20
EXA Signal Analyzer	KEYSIGHT	N9010A-526	MY54510322	Feb. 26,19	Feb. 25,20
Bilog Antenna 1	ETS-LINDGREN	3143B	00161964	Feb. 26,19	Feb. 25,20
Bilog Antenna 2	ETS-LINDGREN	3143B	00161965	Feb. 26,19	Feb. 25,20
Horn Antenna 1	ETS-LINDGREN	3117	00168728	Feb. 26,19	Feb. 25,20
Horn Antenna 2	ETS-LINDGREN	3117	00168692	Nov. 30, 18	Nov. 29, 19
Horn Antenna (18GHz-40GHz)	N/A	QWH-SL-18-40-K-SG/QMS-00361	15433	Nov. 21, 18	Nov. 20, 19
Radio Communication Analyzer	ANRITSU	MT8820C	6201465426	Feb. 26,19	Feb. 25,20
Signal Pre-Amplifier	EMSI	EMC 9135	980249	Jul. 09,19	Jul. 08,20
Signal Pre-Amplifier	EMSI	EMC 012645B	980257	Jul. 09,19	Jul. 08,20
Signal Pre-Amplifier	EMSI	EMC 184045B	980259	Jul. 09,19	Jul. 08,20
3m Semi-anechoic Chamber	ETS-LINDGREN	9m*6m*6m	Euroshieldpn-CT0001143-1216	Feb. 26,19	Feb. 25,20
Test Software	E3	V 9.160323	N/A	N/A	N/A
Test Software	ADT	ADT_Radiated_V7.6.15.9.2	N/A	N/A	N/A
10dB Attenuator	JFW/USA	50HF-010-SM A	1505	Jul. 09,19	Jul. 08,20
Power Meter	Anritsu	ML2495A	1506002	Feb. 26,19	Feb. 25,20
Power Sensor	Anritsu	MA2411B	1339352	Feb. 26,19	Feb. 25,20
Humid & Temp Programmable Tester	Juyi	ITH-120-45-CP-AR	IAA1504-001	Jul. 09,19	Jul. 08,20
MXG Analog Microvave Signal Generator	KEYSIGHT	N5183A	MY50143024	Feb. 26,19	Feb. 25,20

- NOTE:**
1. The calibration interval of the above test instruments is 12 months or 24 months and the calibrations are traceable to CEPREI/CHINA, GRGT/CHINA and NIM/CHINA.
 2. The test was performed in 3m Semi-anechoic Chamber and RF Oven Room.
 3. The horn antenna is used only for the measurement of emission frequency above 1GHz if tested.
 4. The IC test Site Registration No. is 21771-1; The CAB Identifier No. is CN0007.



3 GENERAL INFORMATION

3.1 GENERAL DESCRIPTION OF EUT

PRODUCT	B Series	
MODEL NAME	B402, B404	
POWER SUPPLY	3.8Vdc (Li-ion, battery)	
MODULATION TECHNOLOGY	LTE	QPSK, 16QAM
FREQUENCY RANGE	LTE Band 4 Channel Bandwidth: 1.4MHz	1710.7MHz ~ 1754.3MHz
EMISSION DESIGNATOR	LTE Band 4 Channel Bandwidth: 1.4MHz	QPSK: 1M24G7D
		16QAM: 1M13W7D
MAX. ERP/EIRP POWER	LTE Band 4 Channel Bandwidth: 1.4MHz	276mW
ANTENNA TYPE	Fixed External Antenna with 3.5dBi	
HW VERSION	306A05	
SW VERSION	L0.0.00.00.05.06	
ACCESSORY DEVICE	Refer to user's manual	
DATA CABLE	N/A	

NOTE:

1. For a more detailed features description, please refer to the manufacturer's specifications or the user's manual.
2. For the test results, the EUT had been tested with all conditions. But only the worst case was shown in test report.
3. The differences of B402 and B404 are as follow: B402 uses eSIM of Kore.B404 uses eSIM of Twilio.

3.2 CONFIGURATION OF SYSTEM UNDER TEST

FOR RADIATION EMISSION TEST

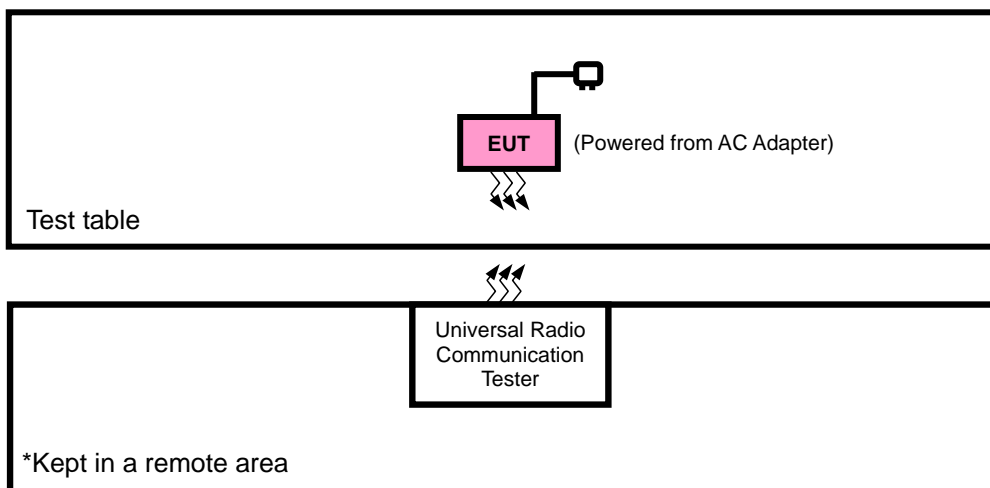

FOR CONDUCTED & E.I.R.P TEST

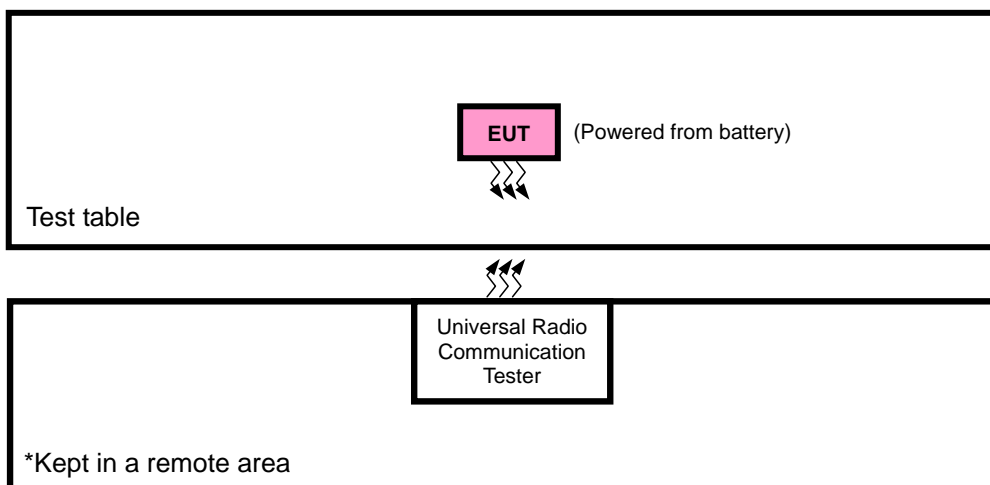



3.3 DESCRIPTION OF SUPPORT UNITS

The EUT has been tested as an independent unit together with other necessary accessories or support units. The following support units or accessories were used to form a representative test configuration during the tests.

NO.	PRODUCT	BRAND	MODEL NO.	SERIAL NO.	FCC ID
1	DC source	LONG WEI	PS-6403D	010934269	N/A
2	PC	HP	A6608CN	3CR83825X3	N/A
3	USB	N/A	N/A	N/A	N/A
4	Battery	N/A	N/A	N/A	N/A

NO.	SIGNAL CABLE DESCRIPTION OF THE ABOVE SUPPORT UNITS
1	DC Line: Unshielded, Detachable 1.0m
2	AC Line: Unshielded, Detachable 1.5m
3	N/A
4	N/A

3.4 DESCRIPTION OF TEST MODES

Pre-Scan has been conducted to determine the worst-case mode from all possible combinations between available modulations, data rates, XYZ axis and antenna ports. The worst case was found when positioned on X-plane for EIRP and X-axis for radiated emission. Following channel(s) was (were) selected for the final test as listed below:

EUT CONFIGURE MODE	DESCRIPTION
-	EUT + Battery with LTE link



LTE BAND 4

EUT CONFIGURE MODE	TEST ITEM	AVAILABLE CHANNEL	TESTED CHANNEL	CHANNEL BANDWIDTH	MODULATION	MODE
-	EIRP	19957 to 20393	19957, 20175, 20393	1.4MHz	QPSK, 16QAM	1 RB / 0 RB Offset
-	RADIATED EMISSION	19957 to 20393	19957, 20175, 20393	1.4MHz	QPSK	1 RB / 0 RB Offset

Note: This device was tested under all bandwidths, RB configurations and modulations. The worst case was found in QPSK modulation.

TEST CONDITION:

TEST ITEM	ENVIRONMENTAL CONDITIONS	INPUT POWER	TESTED BY
EIRP(ERP)	24deg. C, 60%RH	3.8Vdc from Battery	Star Le
RADIATED EMISSION	26deg. C, 56%RH	3.8Vdc from Battery	Star Le

3.5 GENERAL DESCRIPTION OF APPLIED STANDARDS

The EUT is a RF product. According to the specifications of the manufacturer, it must comply with the requirements of the following standards:

Canada RSS-139, Issue 3, July 2015

Canada RSS-Gen, Issue 5, April 2018

ANSI C63.26 - 2015

NOTE: All test items have been performed and recorded as per the above standards.



4 TEST TYPES AND RESULTS

4.1 OUTPUT POWER MEASUREMENT AND POWER CONTROL

4.1.1 LIMITS OF OUTPUT POWER MEASUREMENT

Fixed, mobile, and portable (hand-held) stations operating in the 1710–1755 MHz band are limited to 1 watt EIRP.

4.1.2 TEST PROCEDURES

EIRP / ERP MEASUREMENT:

- a. The EUT was set up for the maximum power with LTE link data modulation. The power was measured with R&S Spectrum Analyzer. All measurements were done at 3 channels (low, middle and high operational frequency range). RBW and VBW is 10MHz for LTE.
- b. E.I.R.P power measurement. In the semi-anechoic chamber, EUT placed on the 1.5m height of Turn Table, rotated the table around 360 degrees to search the maximum radiation power and receiver antenna shall be rotated vertical and horizontal polarization and moved height from 1m to 4m to find the maximum polar radiated power. The “Read Value” is the spectrum reading the maximum power value.
- c. The substitution horn antenna is substituted for EUT at the same position and signals generator export the CW signal to the substitution antenna via a TX cable. Rotated the Turn Table and moved receiving antenna to find the maximum radiation power. Adjust output power level of S.G to get a Value of spectrum reading equal to “Read Value” of step a. Record the power level of S.G
- d. $EIRP = \text{Output power level of S.G} - \text{TX cable loss} + \text{Antenna gain of substitution horn}$
- e. $E.R.P = E.I.R.P - 2.15 \text{ dB}$

CONDUCTED POWER MEASUREMENT:

- a. The EUT was set up for the maximum power with LTE link data modulation and link up with simulator.
- b. Set the EUT to transmit under low, middle and high channel and record the power level shown on simulator.

4.1.3 TEST SETUP

EIRP / ERP Measurement:

<Radiated Emission below or equal 1 GHz>

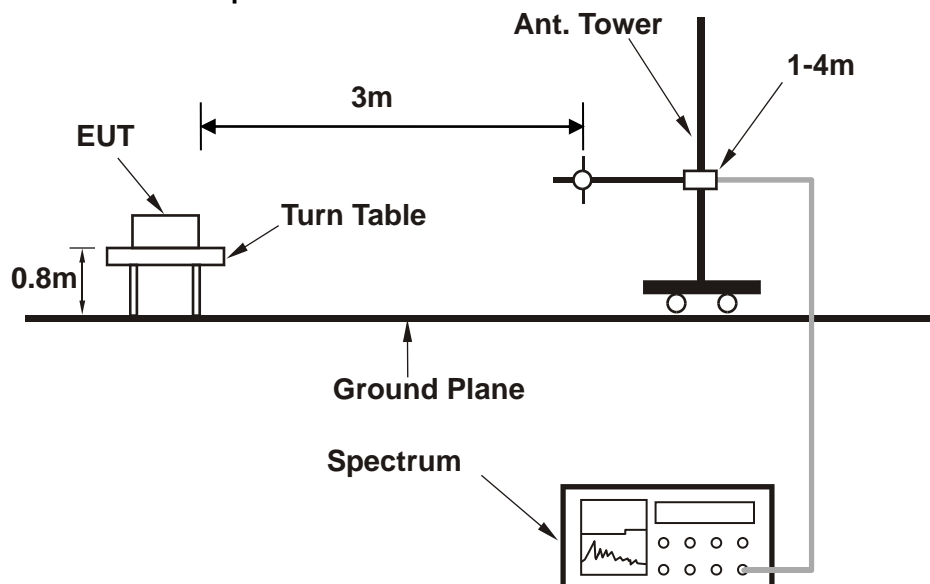

<Radiated Emission above 1 GHz>

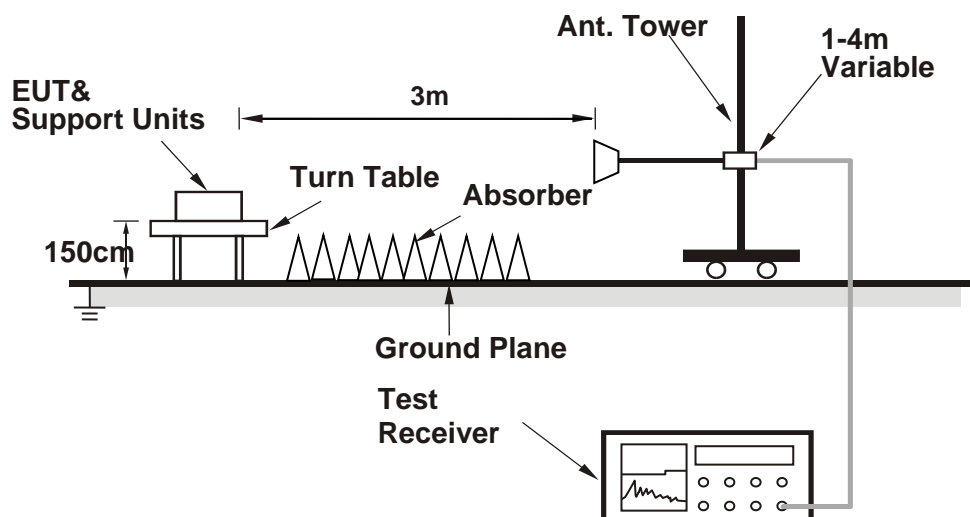

For the actual test configuration, please refer to the attached file (Test Setup Photo).

CONDUCTED POWER MEASUREMENT:

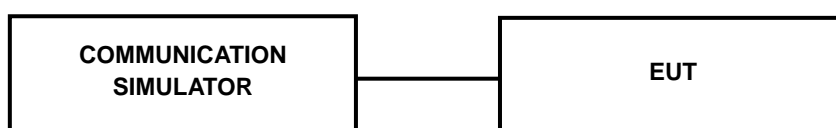



4.1.4 TEST RESULTS

AVERAGE CONDUCTED OUTPUT POWER (dBm)

Base on verify the Conducted Power is the same with module test report (SD72132148-1017A REV.1) by lab, the test results please refer the module Report No.: SD72132148-1017A REV.1, and the pre-scan data as below.

LTE Band 4				
modulation	bandwidth	channels	Frequency	Tx Average (dBm)
QPSK	1.4 MHz	19957	1710.7	23.77
		20175	1732.5	23.72
		20393	1754.3	23.40
16QAM	1.4 MHz	19957	1710.7	23.78
		20175	1732.5	23.74
		20393	1754.3	23.41

TRANSMITTER POWER CONTROL

As Power measured in Clause 4.1.4, the maximum power was limited to 24.5 dBm in QPSK and 16QAM Communication by tune-up procedure.



BUREAU
VERITAS

Test Report No.: ICP20120006-3

EIRP

LTE BAND 4

CHANNEL BANDWIDTH: 1.4MHz QPSK

Channel	Frequency (MHz)	SPA LVL (dBm)	Correction Factor(dB)	EIRP(dBm)	EIRP(mW)	Polarization (H/V)	LIMIT (W)
19957	1710.7	-19.12	41.29	22.17	164.97	H	1
20175	1732.5	-18.74	41.36	22.62	182.81	H	1
20393	1754.3	-18.33	42.74	24.41	275.93	H	1
19957	1710.7	-22.71	44.25	21.54	142.40	V	1
20175	1732.5	-22.02	44.20	22.18	165.20	V	1
20393	1754.3	-22.44	44.09	21.65	146.05	V	1

CHANNEL BANDWIDTH: 1.4MHz 16QAM

Channel	Frequency (MHz)	SPA LVL (dBm)	Correction Factor(dB)	EIRP(dBm)	EIRP(mW)	Polarization (H/V)	LIMIT (W)
19957	1710.7	-19.99	41.29	21.30	135.02	H	1
20175	1732.5	-19.67	41.36	21.69	147.57	H	1
20393	1754.3	-19.29	42.74	23.45	221.21	H	1
19957	1710.7	-23.58	44.25	20.67	116.55	V	1
20175	1732.5	-22.95	44.20	21.25	133.35	V	1
20393	1754.3	-23.40	44.09	20.69	117.08	V	1

REMARKS: 1. EIRP Output Power (dBm) = SPA LVL (dBm) + Correction Factor (dB).

2. Correction factor (dB) = Free Space Loss + Antenna Factor + Cable Loss



4.2 FREQUENCY STABILITY MEASUREMENT

4.2.1 LIMITS OF FREQUENCY STABILITY MEASUREMENT

The frequency stability shall be sufficient to ensure that the fundamental emissions stay within the authorized bands of operation.

4.2.2 TEST PROCEDURE

- a. Device is placed at the oven room. The oven room could control the temperatures and humidity. Power warm up is at least 15 min and power applied should perform before recording frequency error.
- b. EUT is connected the external power supply to control the DC input power. The test voltage range is from minimum to maximum working voltage. Each step shall be record the frequency error rate.
- c. The temperature range step is 10 degrees in this test items. All temperature levels shall be hold the $\pm 0.5^{\circ}\text{C}$ during the measurement testing. The each temperature step shall be at least 0.5 hours, consider the EUT could be test under the stability condition.

NOTE: The frequency error was recorded frequency error from the communication simulator.

4.2.3 TEST SETUP

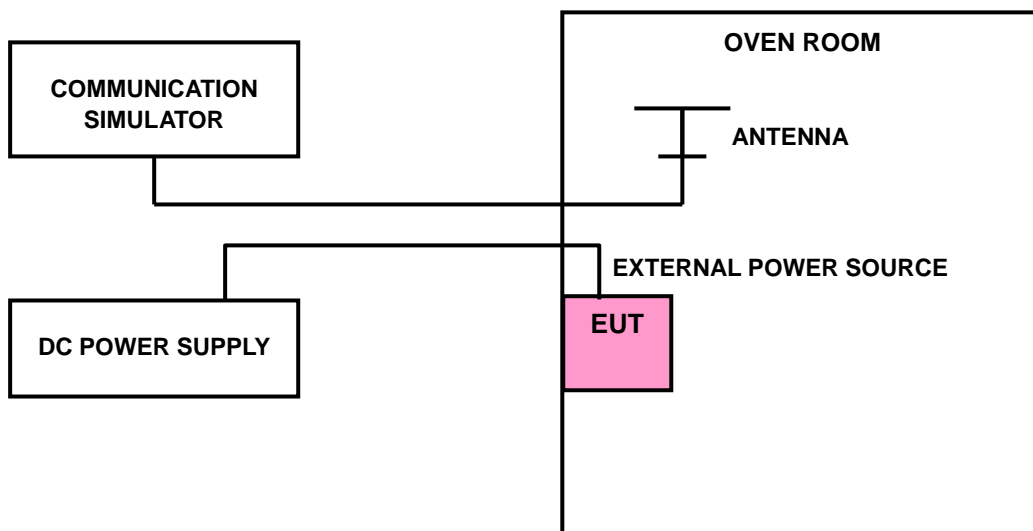

4.2.4 TEST RESULTS

The test results was recorded in Report No.:SD72132148-1017A REV.1.

4.3 OCCUPIED BANDWIDTH MEASUREMENT

4.3.1 LIMITS OF OCCUPIED BANDWIDTH MEASUREMENT

The width of a frequency band such that, below the lower and above the upper frequency limits, the mean powers emitted are each equal to a specified percentage 0.5 %of the total mean power of a given emission.

4.3.2 TEST SETUP

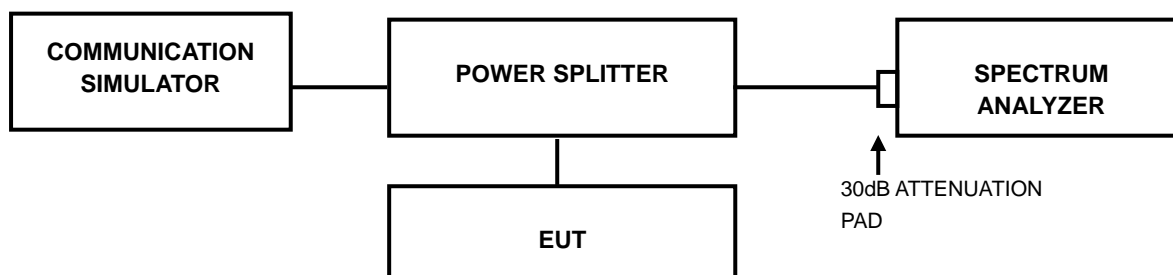

4.3.3 TEST PROCEDURES

- a. The conducted occupied bandwidth used the power splitter via EUT RF power connector between simulation base station and spectrum analyzer.
- b. Use OBW measurement function of Spectrum analyzer to measure 99 % occupied bandwidth.

4.3.4 TEST RESULTS

The test results was recorded in Report No.:SD72132148-1017A REV.1.



4.4 PEAK TO AVERAGE RATIO

4.4.1 LIMITS OF PEAK TO AVERAGE RATIO MEASUREMENT

In measuring transmissions in this band using an average power technique, the peak to-average ratio (PAR) of the transmission may not exceed 13 dB

4.4.2 TEST SETUP

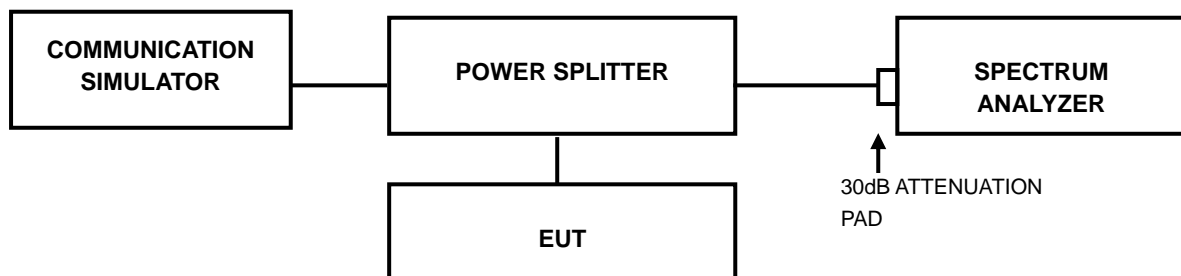

4.4.3 TEST PROCEDURES

1. Set resolution/measurement bandwidth \geq signal's occupied bandwidth;
2. Set the number of counts to a value that stabilizes the measured CCDF curve;
3. Record the maximum PAPR level associated with a probability of 0.1%.

4.4.4 TEST RESULTS

The test results was recorded in Report No.:SD72132148-1017A REV.1.

4.5 BAND EDGE MEASUREMENT

4.5.1 LIMITS OF BAND EDGE MEASUREMENT

The power of any emission outside a licensee's frequency band(s) of operation shall be attenuated below the transmitter power (P) within the licensed band(s) of operation, measured in watts, by at least $43 + 10 \log (P)$ dB. Compliance with this provision is based on the use of measurement instrumentation employing a resolution bandwidth of 100 kilohertz or greater.

However, in the 100 kilohertz bands immediately outside and adjacent to a licensee's frequency block, a resolution bandwidth of at least 30 kHz may be employed.

4.5.2 TEST SETUP

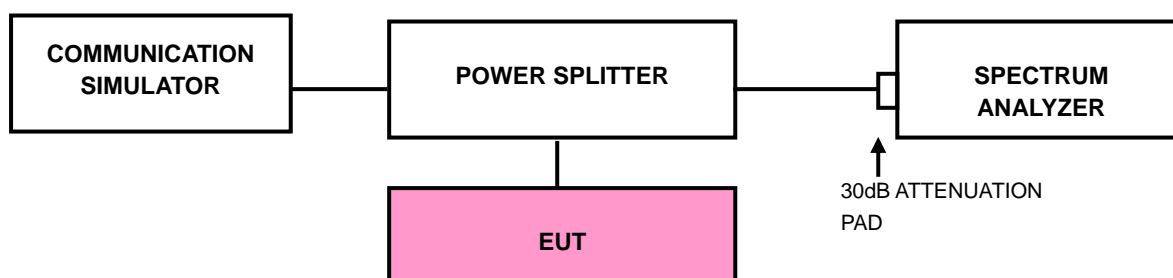



Test Report No.: ICP20120006-3

4.5.3 TEST PROCEDURES

- a. The EUT was set up for the maximum peak power with LTE link data modulation. The power was measured with R&S Spectrum Analyzer. All measurements were done at 2 channels (low and high operational frequency range.).
- b. The band edge measurement used the power splitter via EUT RF power connector between simulation base station and spectrum analyzer.
- c. The center frequency of spectrum is the band edge frequency and span is 1~5 MHz. RBW of the spectrum is 20kHz and VBW of the spectrum is 100 kHz. (LTE bandwidth 1.4MHz)
- d. Record the max trace plot into the test report.

4.5.4 TEST RESULTS

The test results was recorded in Report No.:SD72132148-1017A REV.1.

4.6 CONDUCTED SPURIOUS EMISSIONS

4.6.1 LIMITS OF CONDUCTED SPURIOUS EMISSIONS MEASUREMENT

The power of any emission outside a licensee's frequency block shall be attenuated below the transmitter power (P) by at least $43 + 10 \log_{10}(P)$ dB. The limit of emission equal to -13dBm .

4.6.2 TEST PROCEDURE

- a. The EUT makes a phone call to the communication simulator. All measurements were done at middle operational frequency range.
- b. Measuring frequency range is from 30 MHz to 19.1GHz for LTE Band 4. 10dB attenuation pad is connected with spectrum. RBW=1MHz and VBW=3MHz are used for conducted emission measurement.

4.6.3 TEST SETUP

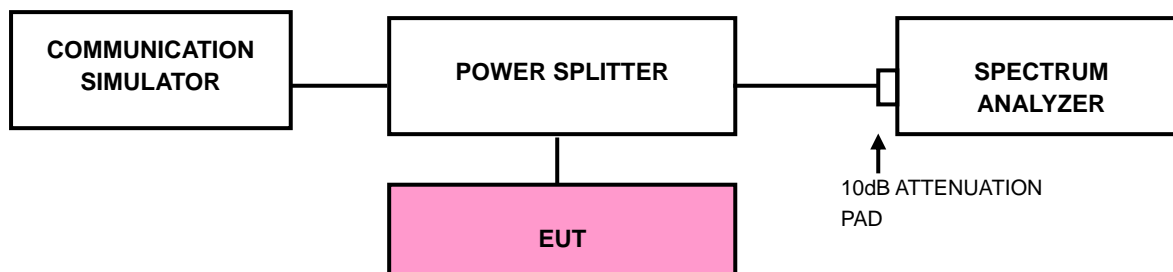

4.6.4 TEST RESULTS

The test results was recorded in Report No.:SD72132148-1017A REV.1.



4.7 RADIATED EMISSION MEASUREMENT

4.7.1 LIMITS OF RADIATED EMISSION MEASUREMENT

The power of any emission outside a licensee's frequency block shall be attenuated below the transmitter power (P) by at least $43 + 10 \log_{10}(P)$ dB. The limit of emission equal to -13dBm

4.7.2 TEST PROCEDURES

- a. Substitution method is used for E.I.R.P measurement. In the semi-anechoic chamber, EUT placed on the 0.8m/1.5m height of Turn Table, rotated the table around 360 degrees to search the maximum radiation power and receiver antenna shall be rotated vertical and horizontal polarization and moved height from 1m to 4m to find the maximum polar radiated power. The "Read Value" is the spectrum reading the maximum power value.
- b. The substitution horn antenna is substituted for EUT at the same position and signals generator export the CW signal to the substitution antenna via a TX cable. Rotated the Turn Table and moved receiving antenna to find the maximum radiation power. Adjust output power level of S.G to get a Value of spectrum reading equal to "Read Value" of step a. Record the power level of S.G
- c. $\text{EIRP} = \text{Output power level of S.G} - \text{TX cable loss} + \text{Antenna gain of substitution horn.}$
- d. E.R.P power can be calculated form E.I.R.P power by subtracting the gain of dipole, $\text{E.R.P power} = \text{E.I.P.R power} - 2.15\text{dBi.}$

NOTE: The resolution bandwidth of spectrum analyzer is 1 MHz and the video bandwidth is 3 MHz.

4.7.3 DEVIATION FROM TEST STANDARD

No deviation

4.7.4 TEST SETUP

< Frequency Range 30MHz~1GHz >

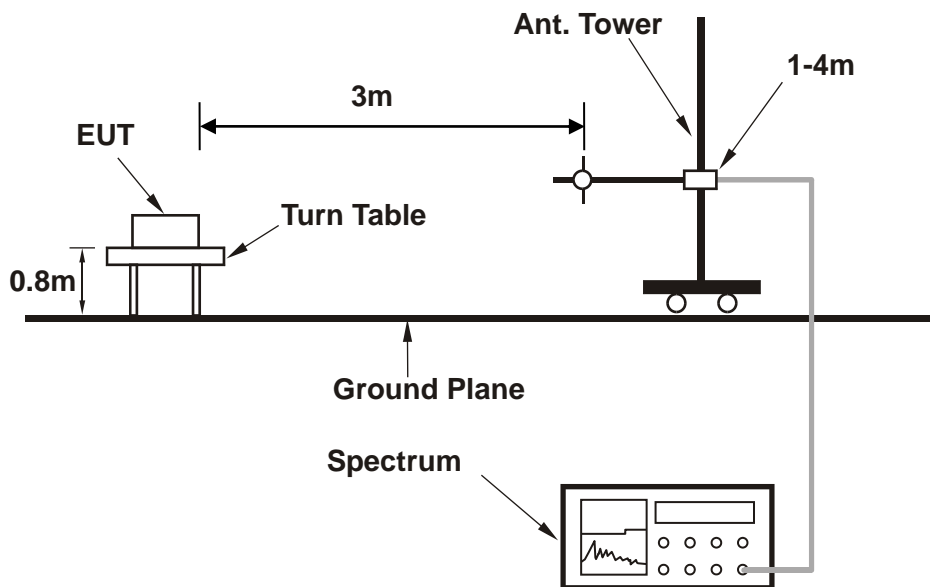

< Frequency Range above 1GHz >

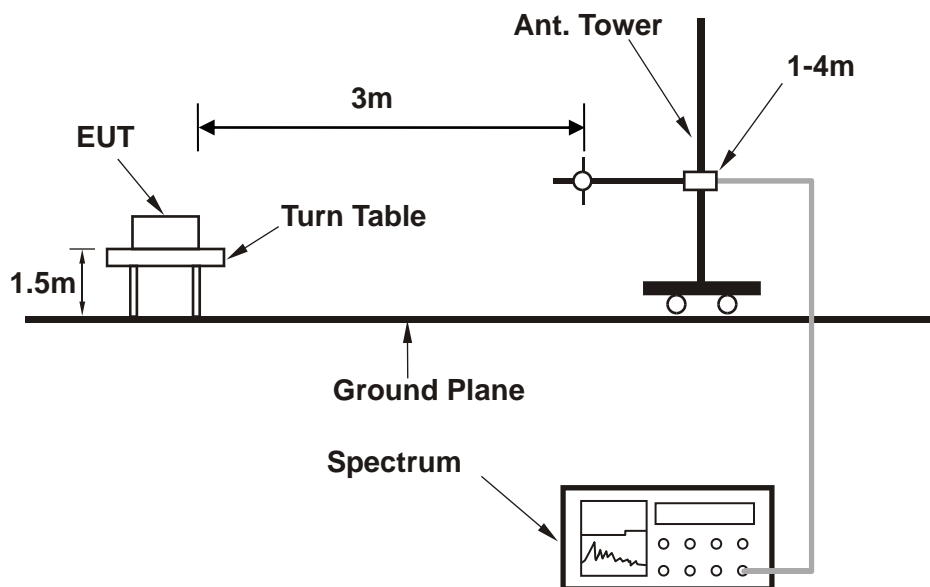

For the actual test configuration, please refer to the attached file (Test Setup Photo).



4.7.5 TEST RESULTS

BELOW 1GHz WORST-CASE DATA

30 MHz – 1GHz data:

LTE Band 4:

CHANNEL BANDWIDTH: 1.4MHz / QPSK

MODE	TX channel 20175	FREQUENCY RANGE	Below 1000MHz
ENVIRONMENTAL CONDITIONS	23deg. C, 70%RH	INPUT POWER	DC 3.8V
TESTED BY	Star Le		
ANTENNA POLARITY & TEST DISTANCE: HORIZONTAL AT 3 M			

	Freq	Level	Read Level	Limit Line	Over Limit	Factor	Remark	Pol/Phase
	MHz	dBm/m	dBm	dBm/m	dB	dB/m		
1	40.670	-32.57	-45.27	-13.00	-19.57	12.70	Peak	Horizontal
2	92.080	-42.29	-51.04	-13.00	-29.29	8.75	Peak	Horizontal
3	136.700	-45.33	-54.13	-13.00	-32.33	8.80	Peak	Horizontal
4 PP	388.900	-29.49	-46.35	-13.00	-16.49	16.86	Peak	Horizontal
5	511.120	-37.47	-56.15	-13.00	-24.47	18.68	Peak	Horizontal
6	599.390	-41.26	-61.35	-13.00	-28.26	20.09	Peak	Horizontal

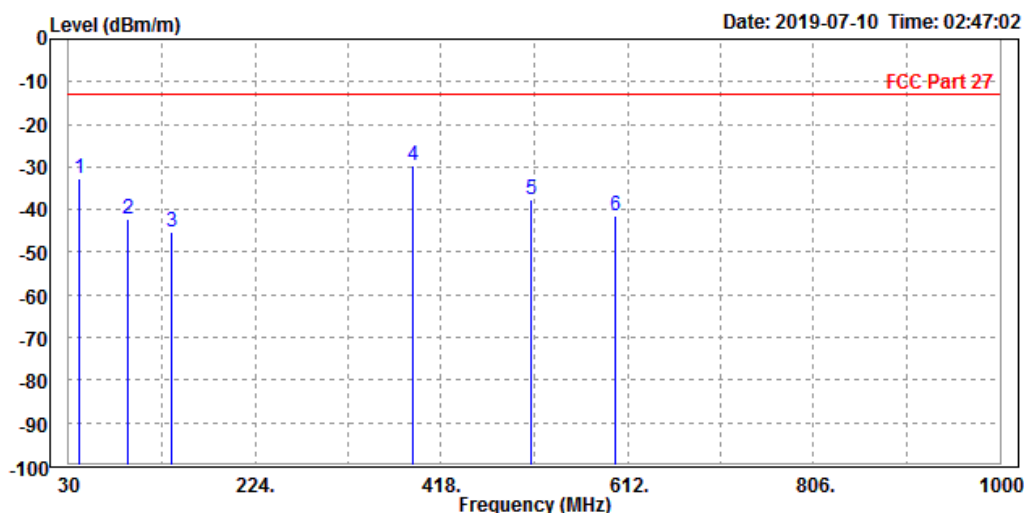



Test Report No.: ICP20120006-3

MODE	TX channel 20175	FREQUENCY RANGE	Below 1000MHz
ENVIRONMENTAL CONDITIONS	23deg. C, 70%RH	INPUT POWER	DC 3.8V
TESTED BY	Star Le		
ANTENNA POLARITY & TEST DISTANCE: VERTICAL AT 3 M			

	Freq	Level	Read Level	Limit Line	Over Limit	Factor	Remark	Pol/Phase
	MHz	dBm/m	dBm	dBm/m	dB	dB/m		
1	PP	39.700	-32.91	-46.63	-13.00	-19.91	13.72 Peak	Vertical
2		129.910	-45.09	-53.79	-13.00	-32.09	8.70 Peak	Vertical
3		313.240	-40.60	-55.21	-13.00	-27.60	14.61 Peak	Vertical
4		378.230	-33.85	-50.48	-13.00	-20.85	16.63 Peak	Vertical
5		508.210	-41.23	-60.04	-13.00	-28.23	18.81 Peak	Vertical
6		644.010	-41.70	-63.08	-13.00	-28.70	21.38 Peak	Vertical

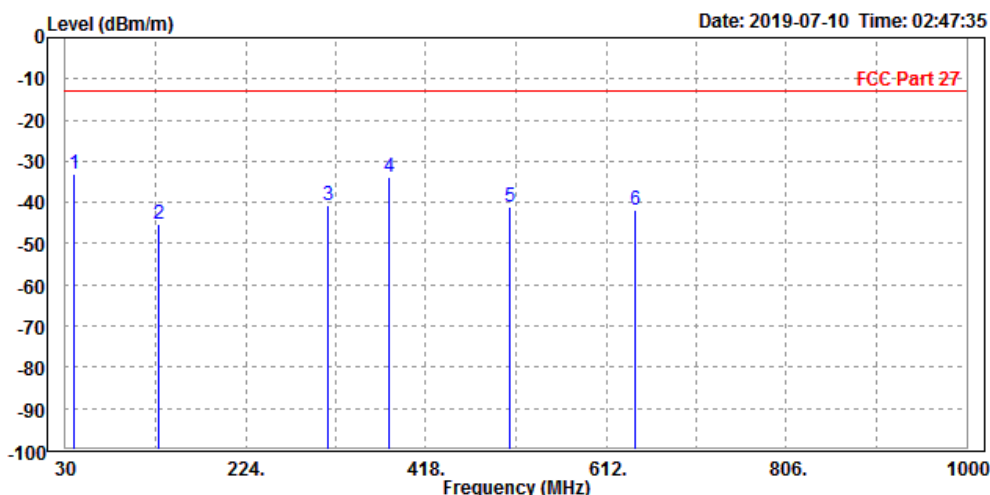



BUREAU VERITAS

Test Report No.: ICP20120006-3

ABOVE 1GHz

Note: For higher frequency, the emission is too low to be detected.

LTE BAND 4

CHANNEL BANDWIDTH: 1.4MHz / QPSK

CH19957

MODE	TX channel 19957	FREQUENCY RANGE	Above 1000MHz
ENVIRONMENTAL CONDITIONS	23deg. C, 70%RH	INPUT POWER	DC 3.8V
TESTED BY	Star Le		
ANTENNA POLARITY & TEST DISTANCE: HORIZONTAL AT 3 M			

	Freq	Level	Read Level	Limit Line	Over Limit	Factor	Remark	Pol/Phase
	MHz	dBm/m	dBm	dBm/m	dB	dB/m		
1 PP	3418.000	-50.61	-52.46	-13.00	-37.61	1.85	Peak	Horizontal
2	5132.000	-56.72	-65.25	-13.00	-43.72	8.53	Peak	Horizontal

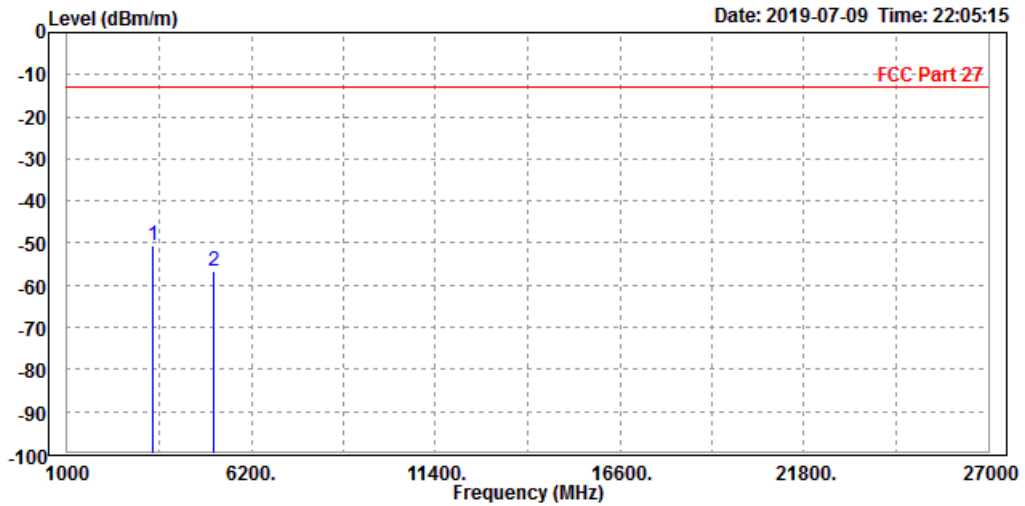



Test Report No.: ICP20120006-3

MODE	TX channel 19957	FREQUENCY RANGE	Above 1000MHz
ENVIRONMENTAL CONDITIONS	23deg. C, 70%RH	INPUT POWER	DC 3.8V
TESTED BY	Star Le		
ANTENNA POLARITY & TEST DISTANCE: VERTICAL AT 3 M			

	Freq	Level	Read Level	Limit Line	Over Limit	Factor	Remark	Pol/Phase
	MHz	dBm/m	dBm	dBm/m	dB	dB/m		
1 PP	3418.000	-50.20	-52.67	-13.00	-37.20	2.47	Peak	Vertical
2	5132.000	-56.24	-64.23	-13.00	-43.24	7.99	Peak	Vertical

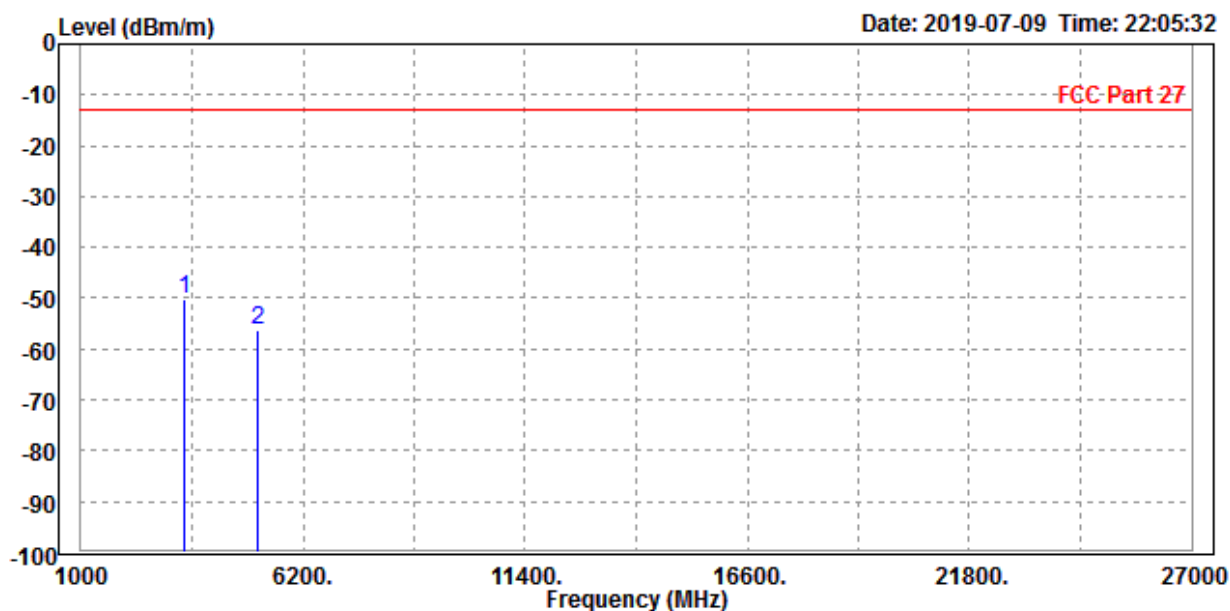



Test Report No.: ICP20120006-3

CH20175

MODE	TX channel 20175	FREQUENCY RANGE	Above 1000MHz
ENVIRONMENTAL CONDITIONS	23deg. C, 70%RH	INPUT POWER	DC 3.8V
TESTED BY	Star Le		
ANTENNA POLARITY & TEST DISTANCE: HORIZONTAL AT 3 M			

	Freq	Level	Read Level	Limit Line	Over Limit	Factor	Remark	Pol/Phase
	MHz	dBm/m	dBm	dBm/m	dB	dB/m		
1 PP	3470.000	-50.31	-52.36	-13.00	-37.31	2.05	Peak	Horizontal
2	5197.000	-55.54	-64.15	-13.00	-42.54	8.61	Peak	Horizontal

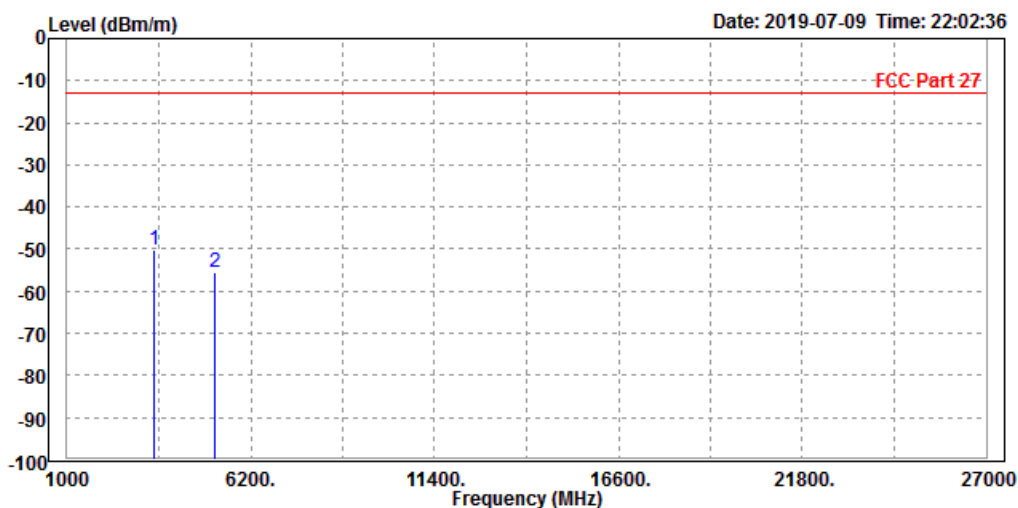



Test Report No.: ICP20120006-3

MODE	TX channel 20175	FREQUENCY RANGE	Above 1000MHz
ENVIRONMENTAL CONDITIONS	23deg. C, 70%RH	INPUT POWER	DC 5V from adapter
TESTED BY	Star Le		
ANTENNA POLARITY & TEST DISTANCE: VERTICAL AT 3 M			

	Freq	Level	Read Level	Limit Line	Over Limit	Factor	Remark	Pol/Phase
	MHz	dBm/m	dBm	dBm/m	dB	dB/m		
1	PP 3470.000	-51.68	-54.21	-13.00	-38.68	2.53	Peak	Vertical
2	5197.000	-57.50	-65.48	-13.00	-44.50	7.98	Peak	Vertical

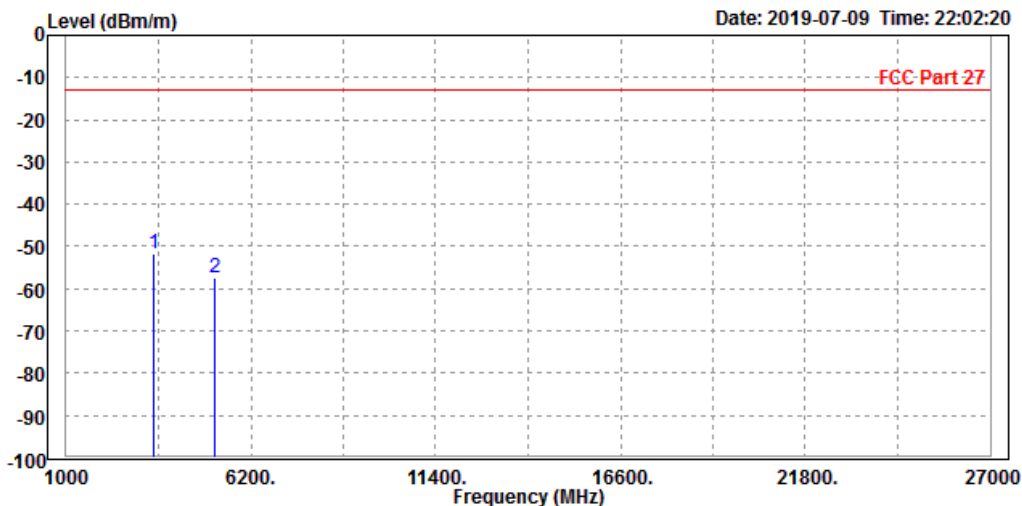



Test Report No.: ICP20120006-3

CH20393

MODE	TX channel 20393	FREQUENCY RANGE	Above 1000MHz
ENVIRONMENTAL CONDITIONS	23deg. C, 70%RH	INPUT POWER	DC 3.8V
TESTED BY	Star Le		
ANTENNA POLARITY & TEST DISTANCE: HORIZONTAL AT 3 M			

	Freq	Level	Read Level	Limit Line	Over Limit	Factor	Remark	Pol/Phase
	MHz	dBm/m	dBm	dBm/m	dB	dB/m		
1	PP 3502.000	-50.48	-52.65	-13.00	-37.48	2.17	Peak	Horizontal
2	5266.000	-55.69	-64.38	-13.00	-42.69	8.69	Peak	Horizontal

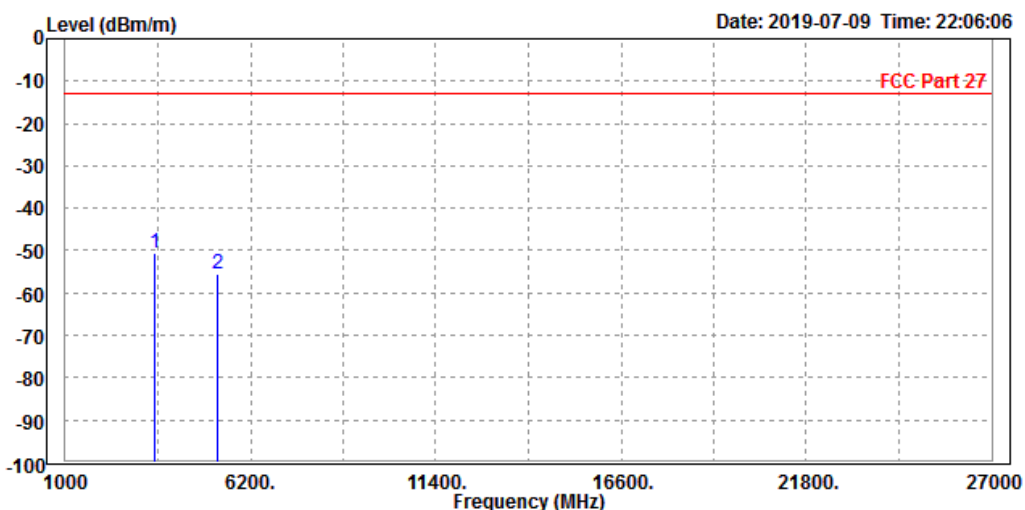



Test Report No.: ICP20120006-3

MODE	TX channel 20393	FREQUENCY RANGE	Above 1000MHz
ENVIRONMENTAL CONDITIONS	23deg. C, 70%RH	INPUT POWER	DC 3.8V
TESTED BY	Star Le		
ANTENNA POLARITY & TEST DISTANCE: VERTICAL AT 3 M			

	Freq	Level	Read Level	Limit Line	Over Limit	Factor	Remark	Pol/Phase
	MHz	dBm/m	dBm	dBm/m	dB	dB/m		
1	PP 3502.000	-50.11	-52.69	-13.00	-37.11	2.58	Peak	Vertical
2	5266.000	-57.23	-65.21	-13.00	-44.23	7.98	Peak	Vertical

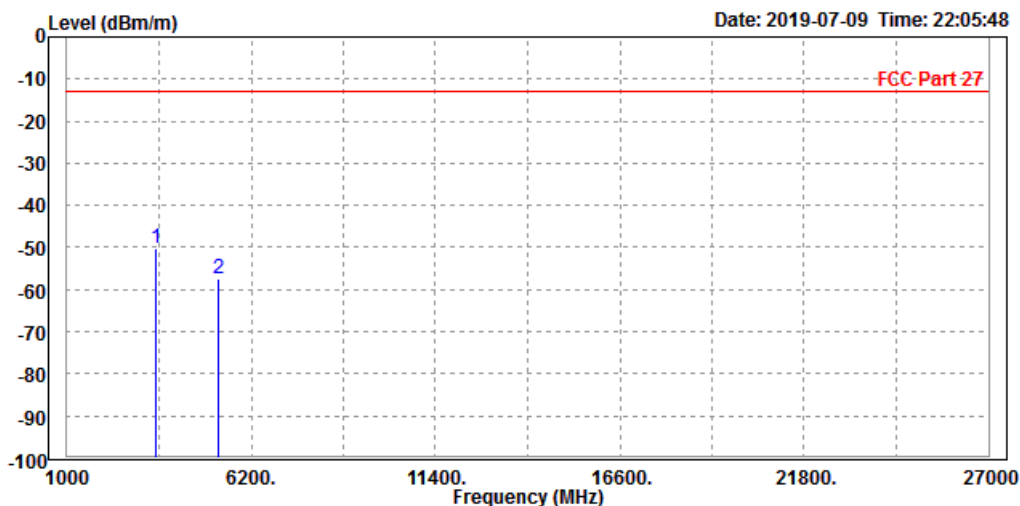



Test Report No.: ICP20120006-3

5 INFORMATION ON THE TESTING LABORATORIES

We, BV 7Layers Communications Technology (Shenzhen) Co. Ltd, were founded in 2015 to provide our best service in EMC, Radio, and Telecom. Our laboratories are accredited and approved according to ISO/IEC 17025.

If you have any comments, please feel free to contact us at the following:

Shenzhen EMC/RF Lab:

Tel: +86 755 8869 6566

Fax: +86 755 8869 6577

Email: customerservice.dg@cn.bureauveritas.com

Web Site: www.adt.com.tw

The address and road map of all our labs can be found in our web site also.



Test Report No.: ICP20120006-3

6 APPENDIX A – MODIFICATIONS RECORDERS FOR ENGINEERING CHANGES TO THE EUT BY THE LAB

No modifications were made to the EUT by the lab during the test.

---END---